

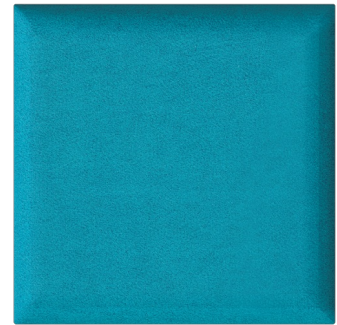

Performance

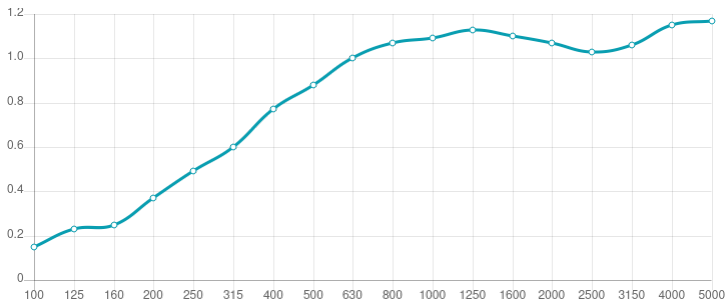

Technical Information

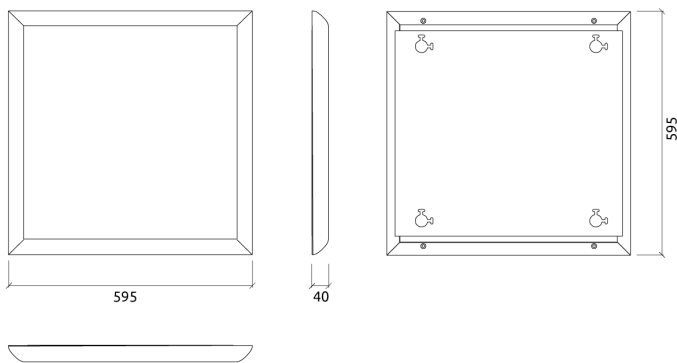

Features

Type: Absorber

Absortion Range: 350 Hz to 5000 Hz

Acoustic Class: B | (aw) = 0,80

Available Fire Rates:
FG | Furniture Grade

Materials:
- Acoustic fabric
- Marine grade plywood structural frame
- Calibrated cell acoustic foam

Four M6 Screw Thread receiver included on each panel.

Integrated Fixing System:
Designed to keep your walls intact, providing a sturdy alternative to glueing panels to your walls. Perfect for temporary instalations, or for rented studios and rooms.
(Fixing already incorporated on the panel)

Dimensions:

FG - SF | 595x595x40mm | 2.12 Kg
FG - WF | 595x595x40mm | 2.17 Kg

Loa Square is an acoustic panel, part of the Loa range. Loa is a fabric covered acoustic panel, sized at 595 x 595mm. Loa Square can be combined with different panels of the range allowing you to perfectly adapt the acoustic treatment to the characteristics of the room. Made of high quality fabric Loa range comes with its own fixing solution, allowing it to be directly on the wall, and the option to be used with Artnovion's fixing systems to be compatible with Artnovion's full range of products.

Product finishes

(FG - SF) Suede Fabric Finishes



(FG - WF) Weave Fabric Finishes

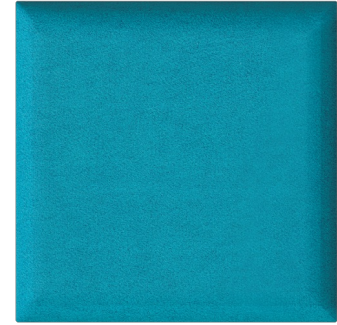
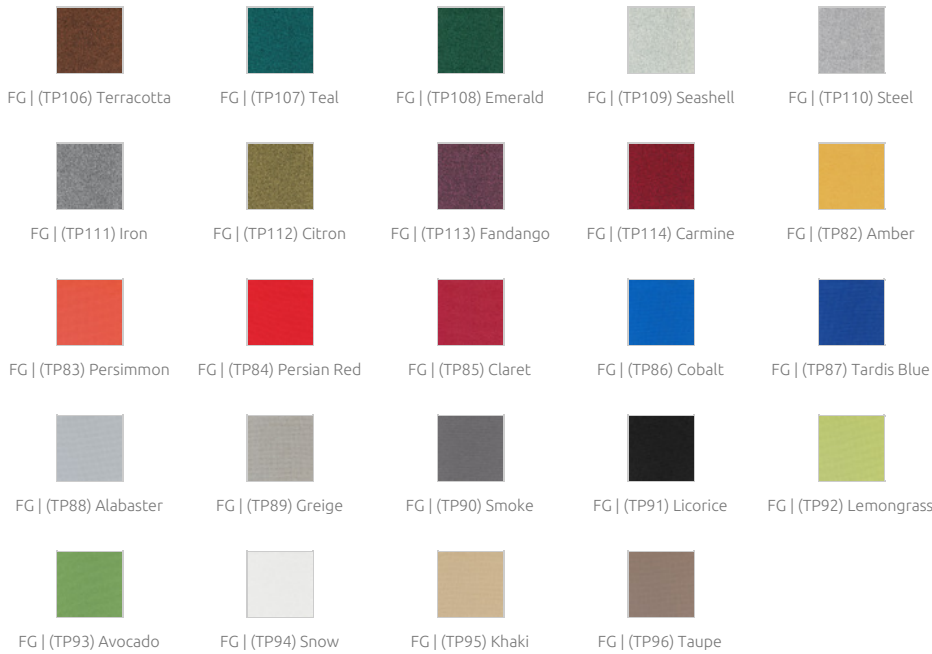

Purpose

- First reflection Control
- RT reduction
- Flutter echo control
- Reducing excessive reverberation
- Improving speech intelligibility

Recommended for

- Hi-Fi Listening Room
- Media Room
- Home Cinema
- Living Room

Fixing Systems



Wall & Ceiling

-  + FixArt Clip
-  + GlueArt 2.0
-  + Instant Fix Kit
-  + FixArt - Tube

Ceiling

-  + FixArt Cloud

Add-ons

-  + FixArt Connect
-  + M6 Screw Thread receiver - Add-on